

# CATALOGO MECCANICA

## MECHANICAL CATALOG



2004

## CLASSIFICAZIONE SECONDO VARIE NORME - SPESSORI E TOLLERANZE DEI RIPORTI

CLASSIFICATION ACCORDING VARIOUS STANDARDS - THICKNESS & PLATING TOLERANCES

USA MESH ISO 6106-79 2° SYSTEM	FEPA NARROW ISO 6106-79 1° SYSTEM	ISO S65 MICRON	DIN 848 FINE	DIN 848 COARSE	CONVENZIONALE CONVENTIONAL	SPESSORE SUL Ø	SPESSORE SUL RAGGIO	TOLLERANZA SUL RAGGIO
8 - 10								
10 - 12								
12 - 14								
14 - 16								
16 - 18	D1181	1180 - 1000		D1100				
16 - 20	*D1182	1180 - 850			24			
18 - 20	D1001	1000 - 850		D900		2,8	1,4	
20 - 25	D851	850 - 710		D700		2,2	1,1	
20 - 30	*D852	850 - 600		D700	36	2,2	1,1	
25 - 30	D711	710 - 600		D700		1,9	0,95	
30 - 35	D601	600 - 500	D550	D500		1,6	0,80	
30 - 40	*D602	600 - 425		D500	46	1,6	0,80	±0,25
35 - 40	D501	500 - 425	D450	D500		1,3	0,65	±0,20
40 - 45	D426	425 - 355		D350				
40 - 50	*D427	425 - 300		D350	60	1,00	0,50	±0,15
45 - 50	D356	355 - 300		D350				
50 - 60	D301	300 - 250	D280	D250		0,80	0,40	±0,1
60 - 70	D251	250 - 212	D220	D250				
60 - 80	*D252	250 - 180			80			
70 - 80	D213	212 - 180	D180	D150		0,60	0,30	±0,06
80 - 100	D181	180 - 150	D180	D150	100			
100 - 120	D151	150 - 125	D140	D150		0,36	0,18	±0,04
120 - 140	D126	125 - 106	D110	D100	120	0,30	0,15	±0,03
140 - 170	D107	106 - 90	D90	D100	140	0,26	0,13	±0,03
170 - 200	D91	90 - 75	D90	D70	160			
200 - 230	D76	75 - 63	D65	D70	200	0,20	0,10	±0,02
230 - 270	D64	63 - 53	D55	D50	230			
270 - 325	D54	53 - 45	D45	D50	270			
325 - 400	D46	45 - 38	D45	D50	400	0,14	0,07	±0,02
	My 60	60 - 40						
	45	54 - 36						
	30	36 - 22						
	15	22 - 12						
	9	12 - 6						
	6	8 - 4						
	3	4 - 2						
	2	3 - 1						
	1	2 - 0,5						
	0,5	0,75 - 0,25						
	0,25	0,25 - 0						

\*) CLASSIFICAZIONE SECONDO FEPA WID / CLASSIFICATION ACCORDING FEPA WID

# UTENSILI DIAMANTATI & CBN

DIAMOND & CBN TOOLS

## PROGRAMMA DI PRODUZIONE PRODUCTION PROGRAM

---

### LIME

FILES

---

### MOLETTE E PASTA DIAMANTATA

GRINDING PINS - POLISHING COMPOUND

---

### MOLE

GRINDING WHEELS

---

### DIAMANTI RAVVIVAMOLE

DIAMOND DRESSERS

---

## ALTRI CATALOGHI DISPONIBILI

---

### LAVORAZIONE MARMO

MARBLE PROCESSING

---

### MOLE SINTERIZZATE RESINOIDI

RESIN BOND DIAMOND AND CBN WHEELS



**LUNGHEZZA TOTALE 140 mm / LUNGHEZZA DIAMANTATA 70 mm**

OVERAL LENGHT 140 mm / DIAMOND LENGHT 70 mm

**ESECUZIONE IN DUE GRANE: GROSSA D 151 / MEDIA D 107**

EXECUTION IN TWO GRAIN SIZES: COARSE D 151 / MEDIUM D 107

	CODICE CODE		SEZIONE SIZE
D 151 D 107	LP 143 LP 142		5,5 x 1,5
D 151 D 107	LP 143 A LP 142 A		5,5 x 1,5
D 151 D 107	LP 143 B LP 142 B		5,5 x 1,5
D 151 D 107	LT 143 LT 142		3 x 3 x 3
D 151 D 107	LQ 143 LQ 142		2,8 x 2,8
D 151 D 107	LR 143 LR 142		∅ 3
D 151 D 107	LH 143 LH 142		5,5 x 2
D 151 D 107	LC 143 LC 142		4,5 x 2,3
D 151 D 107	LK 143 LK 142		5 x 2
D 151 D 107	LB 143 LB 142		5 x 2

**LUNGHEZZA TOTALE 160 mm / LUNGHEZZA DIAMANTATA 80 mm**

OVERAL LENGHT 160 mm / DIAMOND LENGHT 80 mm

**ESECUZIONE IN DUE GRANE: GROSSA D 151 / MEDIA D 107**

EXECUTION IN TWO GRAIN SIZES: COARSE D 151 / MEDIUM D 107

	CODICE CODE		SEZIONE SIZE
D 151 D 107	LP 163 LP 162		6,5 x 2
D 151 D 107	LP 163 A LP 162 A		6,5 x 2
D 151 D 107	LP 163 B LP 162 B		6,5 x 2
D 151 D 107	LT 163 LT 162		4 x 4 x 4
D 151 D 107	LQ 163 LQ 162		3,5 x 3,5
D 151 D 107	LR 163 LR 162		∅ 3,8
D 151 D 107	LH 163 LH 162		6,5 x 2
D 151 D 107	LC 163 LC 162		5,5 x 2,5
D 151 D 107	LK 163 LK 162		5,8 x 2
D 151 D 107	LB 163 LB 162		6 x 2,6

**ASSORTIMENTI / KITS****KIT 05 142** Kit 5 Lime ago 140 D107 / Kit 5 Needle Files D107 (PTQRH)**KIT 05 143** Kit 5 Lime ago 140 D151 / Kit 5 Needle Files D151 (PTQRH)**KIT 05 162** Kit 5 Lime ago 160 D107 / Kit 5 Needle Files D107 (PTQRH)**KIT 05 163** Kit 5 Lime ago 160 D151 / Kit 5 Needle Files D151 (PTQRH)

## LIME DIAMANTATE BIG / DIAMOND FILES BIG

## LIME DIAMANTATE MINI / DIAMOND FILES MINI

2

LUNGHEZZA TOTALE 210 mm / LUNGHEZZA DIAMANTATA 105 mm

OVERAL LENGHT 210 mm / DIAMOND LENGHT 105 mm

ESECUZIONE IN DUE GRANE: SUPER D 213 / MEDIA D 126

EXECUTION IN TWO GRAIN SIZES: SUPER D 213 / MEDIUM D 126

CODICE CODE					
D 126	LP 223	LT 223	LQ 223	LR 223	LH 223
D 213	LP 224	LT 224	LQ 224	LR 224	LH 224

SEZIONE SIZE	SEZIONE SIZE				
					
10 x 2,5	8 x 8	6 x 6	Ø 7	12,5 x 4	



LUNGHEZZA TOTALE 150 mm / LUNGHEZZA DIAMANTATA 45 mm

OVERAL LENGHT 150 mm / DIAMOND LENGHT 45 mm

GRANA STANDARD: D 107

STANDARD GRAIN SIZE: D 107

CODICE CODE					
D 107	LP 152	LT 152	LQ 152	LR 152	LH 152

SEZIONE SIZE	SEZIONE SIZE				
					
4 x 1,4	2,5 x 2,5	1,8 x 1,8	Ø 1,6	4 x 1,5	



ASSORTIMENTI / KITS

KIT 05 223 Kit 5 Lime BIG D126 / KIT 5 BIG Files D126

KIT 05 224 Kit 5 Lime BIG D213 / KIT 5 BIG Files D213

KIT 05 152 KIT 5 pz. Lime MINI / KIT 5 MINI Files

LUNGHEZZA TOTALE 150 mm - LUNGHEZZA DIAMANTATA 25 mm / OVERAL LENGHT 150 mm - DIAMOND LENGHT 25 mm

GRANA STANDARD: D 126 / STANDARD GRAIN SIZE: D 126

CODICE  
CODE

SEZIONE  
SIZE

RF 1



RF 2



RF 3



RF 4



RF 5



RF 6



RF 7



RF 8



ASSORTIMENTI / KITS

KIT 08 RF Kit 8 LIME RIFLOIRS / KIT 8 RIFFLERS FILES



**GRANA: D 126 / GRAIN: D 126**

CODICE CODE	L TOTALE OVERAL LENGHT	L DIAMANTATA DIAMOND LENGHT	SEZIONE SIZE
SLP 691	165 mm.	60 mm.	2 x 12
SLP 692	165 mm.	60 mm.	2 x 12
SLT 693	135 mm.	70 mm.	6 x 6 x 6

**GRANA: D 76 / GRAIN: D 76**

CODICE CODE	L TOTALE OVERAL LENGHT	L DIAMANTATA DIAMOND LENGHT	SEZIONE SIZE
SLP 611	165 mm.	60 mm.	2 x 12
SLP 612	165 mm.	60 mm.	2 x 12

LIME DIAMANTATE A MANO / DIAMOND HAND FILES



**GRANA STANDARD: D 126 / STANDARD GRAIN SIZE: D 126**

CODICE CODE	L TOTALE OVERAL LENGHT	L DIAMANTATA DIAMOND LENGHT	SEZIONE SIZE	CODICE CODE	L TOTALE OVERAL LENGHT	L DIAMANTATA DIAMOND LENGHT	SEZIONE SIZE
LM 31049	165 mm.	75 mm. 3"	10 x 4	LM 61539	250 mm.	150 mm. 6"	15 x 3
				LM 62039	250 mm.	150 mm. 6"	20 x 3
LM 41039	165 mm.	100 mm. 4"	10 x 3	LM 82039	250 mm.	200 mm. 8"	20 x 3
LM 41539	165 mm.	100 mm. 4"	15 x 3	LM 82049	250 mm.	200 mm. 8"	20 x 4
LM 51039	165 mm.	125 mm. 5"	10 x 3	LM 82539	250 mm.	200 mm. 8"	25 x 3
LM 51539	165 mm.	125 mm. 5"	15 x 3	LM 82549	250 mm.	200 mm. 8"	25 x 4

## 5 LIME DIAMANTATE PER MACCHINE A MANO / DIAMOND FILES FOR HAND MACHINE











LUNGHEZZA TOTALE 50 mm / LUNGHEZZA DIAMANTATA 15 mm / GAMBO Ø 3 mm

OVERAL LENGHT 50 mm / DIAMOND LENGHT 15 mm / SHANK Ø 3 mm

### GRANA STANDARD D126

STANDARD GRAIN SIZE D126

CODICE CODE	SEZIONE SIZE	CODICE CODE	SEZIONE SIZE	CODICE CODE	SEZIONE SIZE	CODICE CODE	SEZIONE SIZE	
	DP 15	2 x 1		DP 15 A	2 x 1		DR 15	Ø 1
	DP 25	3 x 1		DP 25 A	3 x 1		DR 25	Ø 2
	DP 35	4 x 1		DP 35 A	4 x 1		DR 35	Ø 3
	DP 45	5 x 2		DP 45 A	5 x 2		DR 45	Ø 4
	DQ 25	3 x 3		DK 15	4 x 1		DR 55	Ø 5
							DT 15	2 x 2
							DT 25	3 x 3
							DC 15	3,5 x 2
							DC 25	6 x 3
							DH 15	3,2 x 1,6

## LIME PER TRAFILA / DRAW BENCH FILES



CODICE CODE	L	H	D	d	$\alpha$	GRANA STANDARD STANDARD GRAIN SIZE
LTR 1432	140	45	3	0,3	4°	D 107
LTR 1442	140	45	4	0,3	6°	D 107
LTR 1459	140	60	5	3,8	2°	D 126
LTR 1869	180	50	6	0,5	6°	D 126
LTR 2089	200	50	8	0,5	9°	D 126







ESECUZIONE IN DUE ABRASIVI: DIAMANTE E CBN / AVAILABLE IN TWO ABRASIVE VERSIONS: DIAMOND AND CBN

GRANULOMETRIE: D46 / D107 / D126 rapportate alla grandezza dell'utensile / GRAIN SIZES: D46 / D107 / D126 according to size of tool

CODICE CBN Es: MCB 0040 / CBN CODE E.g.: MCB 0040

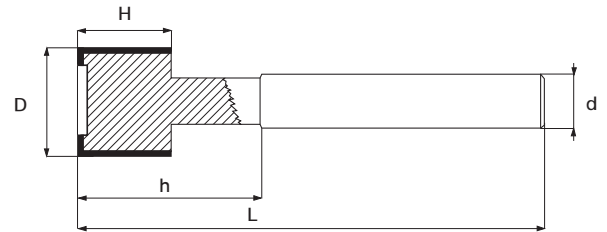
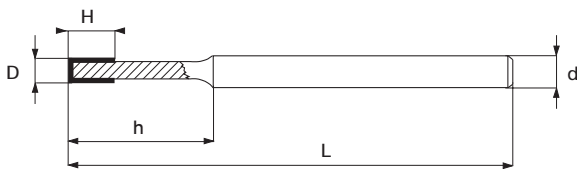

GRANA GRAIN SIZE	COD. DIAMANTE DIAMOND CODE	D mm	H mm	h mm	d mm	L mm
D 46	MC 0050	0,5	2	6	3	55
	MC 0060	0,6	2	9	3	55
	MC 0070	0,7	2	9	3	55
D 107	MC 0080	0,8	3	10	3	55
	MC 0090	0,9	3	12	3	55
	MC 0100	1	4	12	3	55
	MC 0125	1,25	4	14	3	55
	MC 0150	1,5	4	14	3	55
	MC 0175	1,75	4	14	3	55
	MC 0200	2	4	14	3	55
D 126	MC 0250	2,5	4	20	3	55
	MC 0300	3	5	20	3	55
	MC 0350	3,5	5		3	55
	MC 0400	4	5		3	55
	MC 0500	5	5		3	55

GRANA GRAIN SIZE	COD. DIAMANTE DIAMOND CODE	D mm	H mm	h mm	d mm	L mm
D 126	MC 0400L	4	8	35	6	80
	MC 0500L	5	8	35	6	80
	MC 0630	6,3	8		6	80
	MC 0700	7	10		6	80
	MC 0800	8	10		6	80
	MC 0900	9	10		6	80
	MC 1000	10	10		6	80
	MC 1200	12	10		6	80
	MC 1400	14	10		6	80
	MC 1500	15	10		6	80
	MC 1600	16	10		6	80
	MC 1800	18	10		8	80
	MC 2000	20	10		8	80
	MC 2200	22	10		8	80
	MC 2500	25	10		8	80

## MOLETTE DIAMANTATE E CBN PER INTERNI CON FORO / I.D. GRINDING & CBN PINS WITH BORE

8

GRANA STANDARD D126 / STANDARD GRAIN SIZE D126

CODICE CBN Es.: MCB 3010 / CBN CODE E.g.: MCB 3010

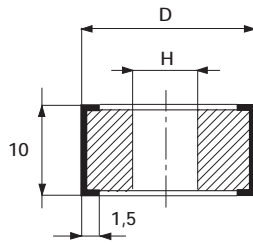

D	H	CODICE CODE	D	H	CODICE CODE
10	6	MC 3010	20	8	MC 3020
12	6	MC 3012	22	8	MC 3022
14	6	MC 3014	25	8	MC 3025
15	6	MC 3015	30	8	MC 3030
16	6	MC 3016	40	10	MC 3040
18	8	MC 3018	50	10	MC 3050

## MOLETTE DIAMANTATE E CBN PER INTERNI SINTERIZZATE / SINTERED I.D. GRINDING DIAMOND & CBN PINS

GRANA STANDARD D151 / STANDARD GRAIN SIZE D151

CONCENTRAZIONE C100 / CONCENTRATION C100

CODICE CBN Es.: MCB 205 S / CBN CODE E.g.: MCB 205 S

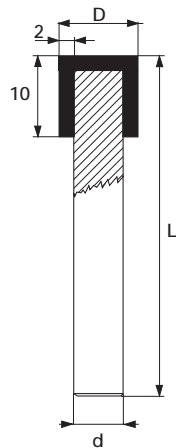

D	d	L	CODICE CODE	D	d	L	CODICE CODE
5	6	50	MC 205 S				
6	6	50	MC 206 S				
8	6	80	MC 208 S				
10	6	80	MC 210 S				
12	6	80	MC 212 S				

## MOLETTE DIAMANTATE E CBN PER INTERNI SINTERIZZATE CON FORO / SINTERED I.D. GRINDING DIAMOND & CBN PINS WITH BORE

CONCENTRAZIONE E GRANA STANDARD: C75 = D91 C100 = D181 / STANDARD CONCENTRATION AND GRAIN SIZE: C75 = D91 C100 = D181

CODICE CBN Es.: MCB 114 S / CBN CODE E.g.: MCB 114 S

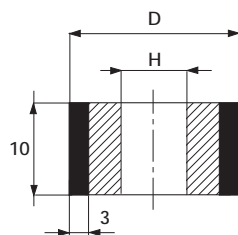

D	H	CODICE C 75 CODE	D	H	CODICE C 100 CODE
14	6	MC 114 S	14	6	MC 214 S
16	6	MC 116 S	16	6	MC 216 S
18	6	MC 118 S	18	6	MC 218 S
20	6	MC 120 S	20	6	MC 220 S
25	8	MC 125 S	25	8	MC 225 S
30	8	MC 130 S	30	8	MC 230 S



ABRASIVO STANDARD: CBN / STANDARD ABRASIVES: CBN

GRANULOMETRIE: B126 / B213 / GRAIN SIZES: B126 / B213

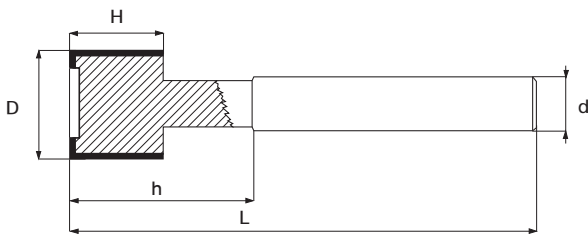

MOLETTE CILINDRICHE / GRINDING PINS

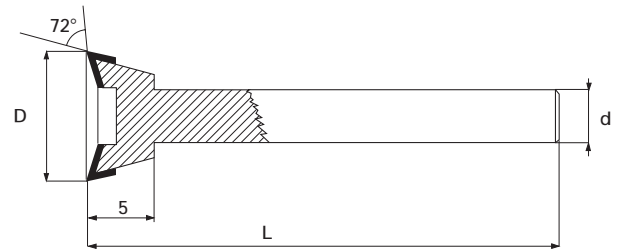

MOLETTE PER FONDI / BOTTOM CBN WHEELS

GRANA GRAIN SIZE	CODICE CODE	D mm	H mm	h mm	d mm	L mm
B 126	MCB 308M	8	10	30	9,52	80
	MCB 310M	10	10	30	9,52	80
	MCB 312M	12	10		9,52	100
	MCB 315M	15	10		9,52	100
	MCB 318M	18	10		9,52	100
	MCB 325M	25	10		9,52	100
B 213	MCB 408M	8	10	30	9,52	80
	MCB 410M	10	10	30	9,52	80
	MCB 412M	12	10		9,52	100
	MCB 415M	15	10		9,52	100
	MCB 418M	18	10		9,52	100
	MCB 425M	25	10		9,52	100

GRANA GRAIN SIZE	CODICE CODE	D mm	H mm	h mm	d mm	L mm
B 126	MFB 3086	8			6	80
	MFB 3106	10			6	80
	MFB 3126	12			6	80
	MFB 3159	15			9,52	100
	MFB 3189	18			9,52	100
	MFB 3259	25			9,52	100
B 213	MFB 4086	8			6	80
	MFB 4106	10			6	80
	MFB 4126	12			6	80
	MFB 4159	15			9,52	100
	MFB 4189	18			9,52	100
	MFB 4259	25			9,52	100



ALTA CONCENTRAZIONE / HIGH CONCENTRATION

LAVORAZIONE OPERATION	GRANA MICRON MICRON GRAIN SIZE	COLORE COLOR	CODICE CODE
LAPPATURA Lapping	0,25	NEUTRO Neutral	PD 0025
LAPPATURA Lapping	1	AVORIO Ivory	PD 01
FINITURA Finishing	3	GIALLO Yellow	PD 03
PREFINITURA Pre finish	6	ARANCIO Orange	PD 06
PREFINITURA Pre finish	9	VERDE Green	PD 09

LAVORAZIONE OPERATION	GRANA MICRON MICRON GRAIN SIZE	COLORE COLOR	CODICE CODE
MEDIA SGROSSATURA Medium grinding	15	BLU Blue	PD 15
MEDIA SGROSSATURA Medium grinding	30	ROSSO Red	PD 30
FORTE SGROSSATURA High grinding	45	MARRONE Brown	PD 45
FORTE SGROSSATURA High grinding	60	VIOLA Violet	PD 60

CONFEZIONE STANDARD : 5 gr. / STANDARD CONFECTION 5 gr.

A RICHIESTA CONFEZIONI DA 18 gr. / UPON REQUESTED CONFECTION 18 gr.

LAPPATORI / DIAMOND LAPPING TOOLS

RESINMENTAL LRM



RESINA LRS



DISCHI TRONCATORI / DISCS FOR CUTTING

GRANA STANDARD D 151 / STANDARD GRAIN SIZE D 151

FORO Ø 20 mm / HOLE Ø 20 mm



	DIAMANTE DIAMOND	CBN		SPESSORE THICKNESS
100	DT 100 D	DT 100 B	SINTERIZZATO	1-1,2 mm.
	D 100 518 D		ELETTRODEPOSTO	1,2 mm.
125	DT 125 D	DT 125 B	SINTERIZZATO	1-1,2 mm.
150	DT 150 D	DT 150 B	SINTERIZZATO	1-1,2 mm.



LUNGHEZZA STANDARD 46 mm / STANDARD LENGHT 46 mm

FC GRANA STANDARD D 126 / FC STANDARD GRAIN SIZE D 126

FR GRANA STANDARD D 427 / FR STANDARD GRAIN SIZE D 427

GAMBO Ø 3 mm DISPONIBILE ANCHE Ø 2,35 mm / SHANK Ø 3 mm ALSO AVAILABLE Ø 2,35 mm

Ø 2	Ø 3	Ø 4	Ø 6	Ø 8	Ø 10	2 x 4	3 x 6	4 x 7	3 x 2,5	5 x 5	
FC 103 020	FC 103 030	FC 103 040	FC 103 060	FC 103 080	FC 103 100	FC 113 020	FC 113 030	FC 113 040	FC 153 030	FC 153 050	
3 x 5	5 x 8	5,8 x 12	2 x 6	3 x 7	2 x 8	3 x 12	4 x 10	3 x 12	3 x 10	4 x 7	6 x 11
FC 163 030	FC 163 050	FC 303 058	FC 353 020	FC 353 030	FC 503 020	FC 503 030	FC 503 040	FC 553 030	FC 563 030	FC 573 040	FC 573 060
4 x 3	6 x 5	5 x 2,5	8 x 2,5	3 x 14	4,5 x 12	5,8 x 14	8,8 x 17	5,8 x 11	5,8 x 11		
FC 583 040	FC 583 060	FC 593 050	FC 633 080	FC 653 030	FC 653 045	FC 653 058	FC 653 088	FC 703 058	FC 723 058		
6 x 12	4,7 x 12	6 x 14	9 x 17	6 x 11	6 x 11						
FR 303 060	FR 653 047	FR 653 060	FR 653 090	FR 703 060	FR 723 060						

GRANA STANDARD: "FC" D126 - "FR" D427 / STANDARD GRAIN SIZE: "FC" D126 - "FR" D427

GAMBO Ø 3 mm DISPONIBILE ANCHE Ø 2,35 mm / SHANK Ø 3 mm ALSO AVAILABLE Ø 2,35 mm

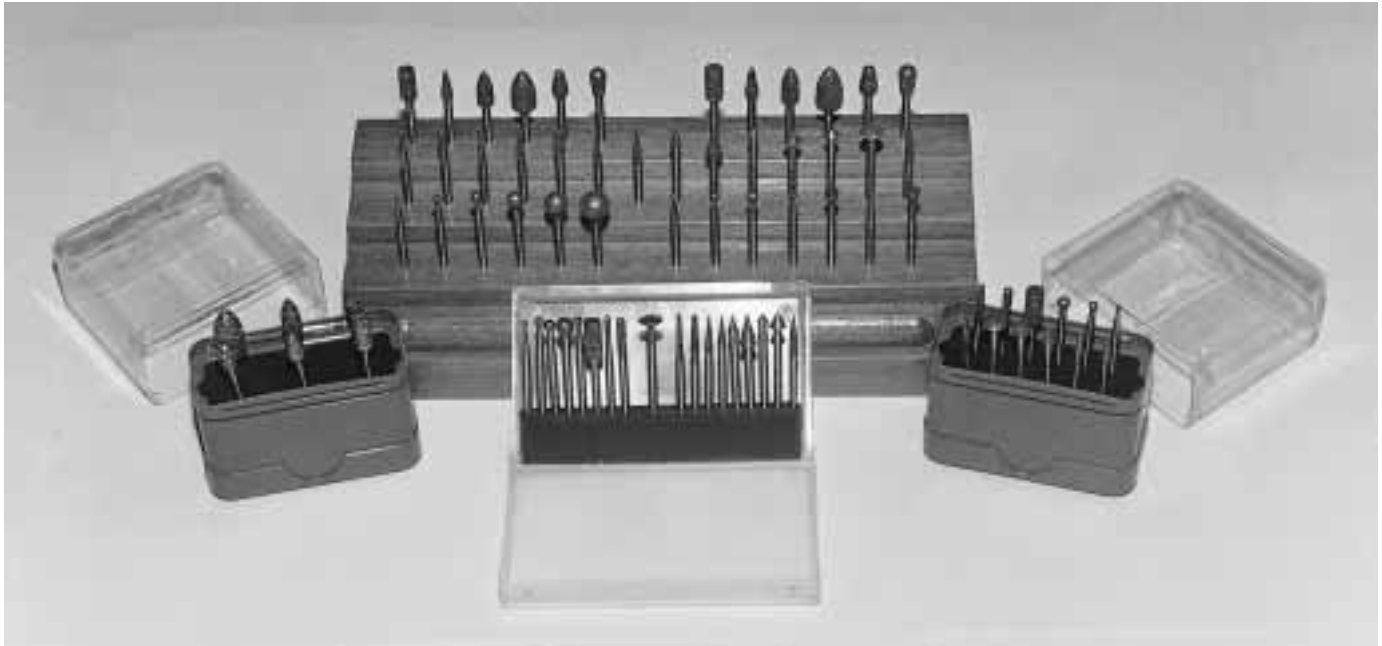

**KIT 6 PEZZI / SET 6 PIECES**

**KIT 6 FR**

COMPOSIZIONE / COMPOSITION

FR 303 060	FR 653 060	FR 703 060
FR 653 047	FR 653 090	FR 723 060

**KIT 12 PEZZI / SET 12 PIECES**

**KIT 12 FC**

COMPOSIZIONE / COMPOSITION

FC 103020	FC 303058	FC 553030	FC 583060
FC 103030	FC 353030	FC 563030	FC 633080
FC 103040	FC 503030	FC 573040	FC 653030

**KIT 18 PEZZI / SET 18 PIECES**

**KIT 18 FC**

COMPOSIZIONE / COMPOSITION

FC 103 020	FC 303 058	FC 553 030	FC 583 060
FC 103 030	FC 353 020	FC 563 030	FC 633 080
FC 103 040	FC 353 030	FC 573 040	FC 653 030
FC 103 060	FC 503 020	FC 573 060	
FC 153 030	FC 503 030	FC 583 040	

**KIT 39 PEZZI / SET 39 PIECES**

**KIT 39 FC**

COMPOSIZIONE / COMPOSITION

FC 103 020	FC 153 050	FC 563 030	FC 653 088
FC 103 030	FC 163 030	FC 573 040	FC 703 058
FC 103 040	FC 163 050	FC 573 060	FC 723 058
FC 103 060	FC 303 058	FC 583 040	FR 303 060
FC 103 080	FC 353 020	FC 583 060	FR 653 047
FC 103 100	FC 353 030	FC 593 050	FR 653 060
FC 113 020	FC 503 020	FC 633 080	FR 653 090
FC 113 030	FC 503 030	FC 653 030	FR 703 060
FC 113 040	FC 503 040	FC 653 045	FR 723 060
FC 153 030	FC 553 030	FC 653 058	



LUNGHEZZA STANDARD 44,5 mm / STANDARD LENGHT 44,5 mm

GAMBO STANDARD Ø 2,35 mm / STANDARD SHANK Ø 2,35 mm

DISEGNI IN GRANDEZZA NATURALE / REAL SIZE DRAWINGS

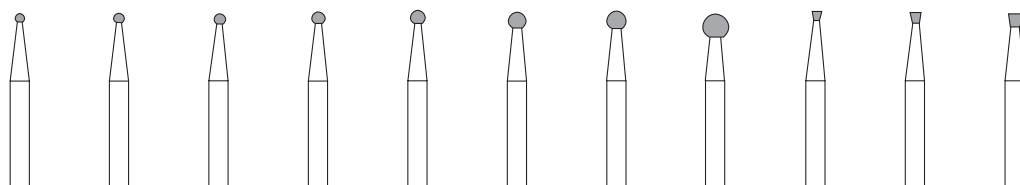

CODICE / CODE	HP 801 010	HP 801 012	HP 801 014	HP 801 016	HP 801 018	HP 801 023	HP 801 027	HP 801 035	HP 805 012	HP 805 016	HP 805 021
PREZZO / PRICE	2	2	2	2	2	4	4	6	2	2	4

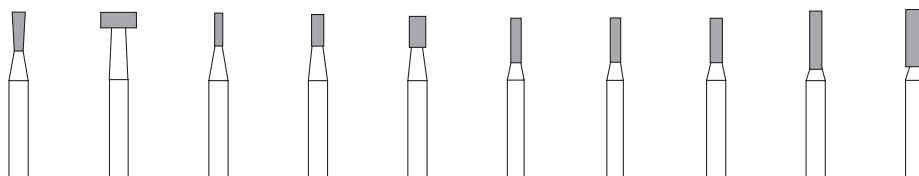

CODICE / CODE	HP 807 016	HP 820 042	HP 835 010	HP 835 014	HP 835 021	HP 836 012	HP 836 014	HP 836 016	HP 837 016	HP 837 025
PREZZO / PRICE	4	6	2	2	4	4	4	4	6	6

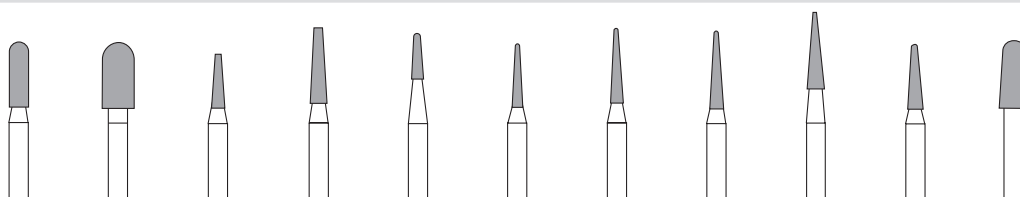

CODICE / CODE	HP 838 025	HP 838 040	HP 847 016	HP 848 022	HP 849 014	HP 858 014	HP 859 016	HP 859 018	HP 859 023	HP 854 018	HP 854 040
PREZZO / PRICE	6	7	4	6	4	4	6	6	6	4	7

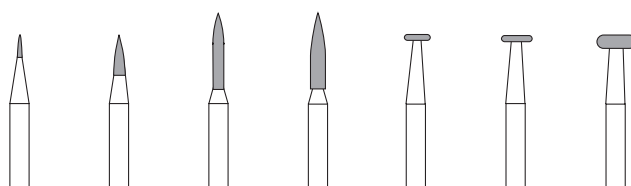

CODICE / CODE	HP 860 010	HP 860 016	HP 863 014	HP 863 018	HP 909 033	HP 909 040	HP 909 050
PREZZO / PRICE	2	2	4	6	6	6	7



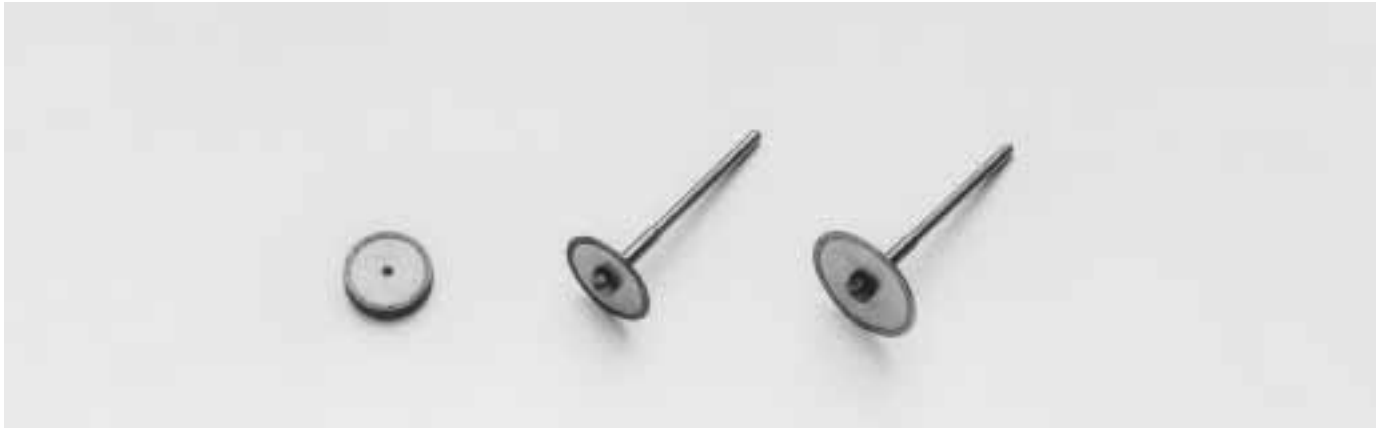

GAMBI DISPONIBILI Ø 2,35 e 3 mm. - SHANK AVAILABLE Ø 2,35 e 3 mm.

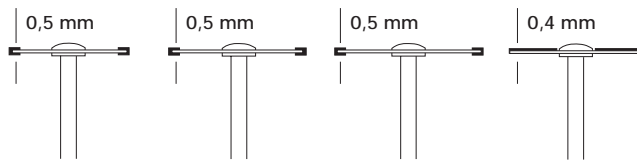

CODICE - Code	910 180	910 200	910 220	916 180
PREZZO NON MONTATI - Unmounted price (disc only)	9	9	10	10
PREZZO MONTATI HP - Mounted HP price (with shank)	10	10	11	11

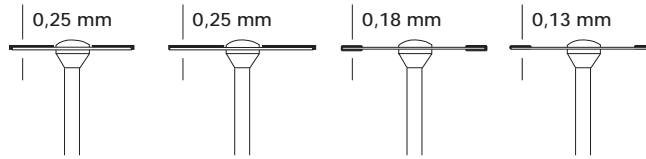

CODICE - Code	F 916 180	F 916 220	S 910 220	S 912 220
PREZZO NON MONTATI - Unmounted price (disc only)				
PREZZO MONTATI HP - Mounted HP price (with shank)	11	12	12	11

CODICE - Code

PREZZO NON MONTATI - Unmounted price (disc only)

PREZZO MONTATI HP - Mounted HP price (with shank)

CODICE - Code

PREZZO NON MONTATI - Unmounted price (disc only)

PREZZO MONTATI HP - Mounted HP price (with shank)

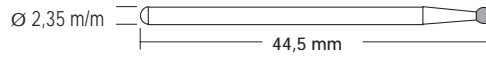

20

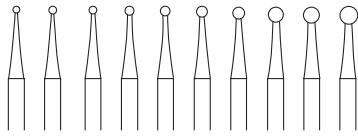

N.	3/0	2/0	0	1	2	3	4	5	6	7
$\varnothing$	006	007	008	009	010	012	014	016	018	021



22

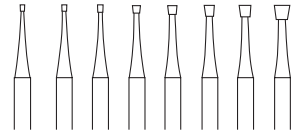

N.	2/0	0	1	2	3	4	5	6
$\varnothing$	007	008	009	010	012	014	016	018



26

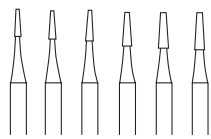

N.	0	1	2	3	4	5
$\varnothing$	008	009	010	012	014	016



28

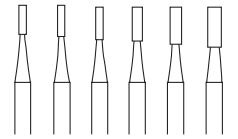

N.	0	1	2	3	4	5
$\varnothing$	008	009	010	012	014	016



36

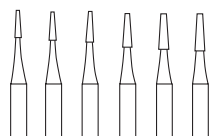

N.	0	1	2	3	4	5
$\varnothing$	008	009	010	012	014	016



38

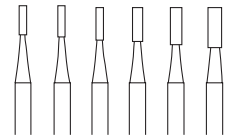

N.	0	1	2	3	4	5
$\varnothing$	008	009	010	012	014	016

LEGANTI: GALVANICO E RESINOIDE / BOND TYPE: GALVANIC AND RESINOID

LAVORAZIONE: A UMIDO - A SECCO / WET AND DRY OPERATION

A RICHIESTA PRODUCIAMO QUALSIASI UTENSILE DIAMANTATO / OTHER TOOLS CAN BE MANUFACTURED UPON SPECIFIC REQUEST

4A2

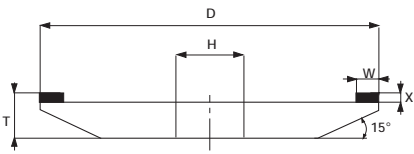

11V9

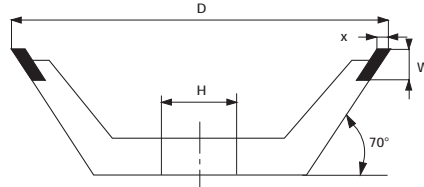

1A1

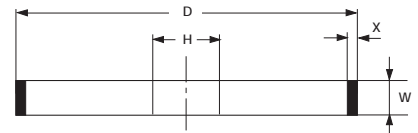

12A220

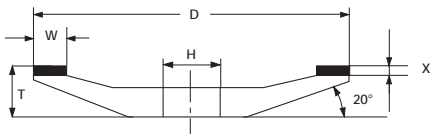

12V9

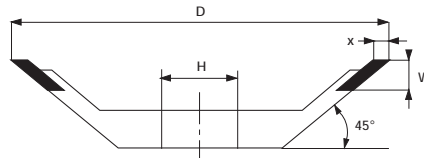

1A1R

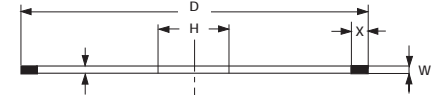

12A245

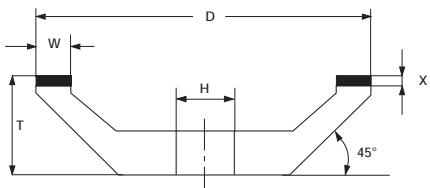

12V2

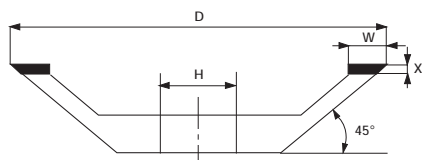

14A1

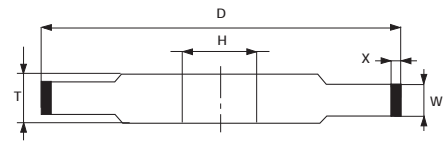

6A2

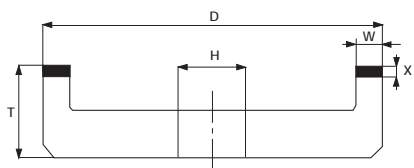

6A9

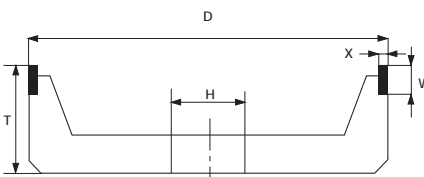

14A1R

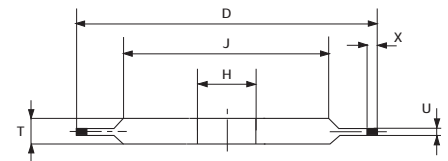

11A2

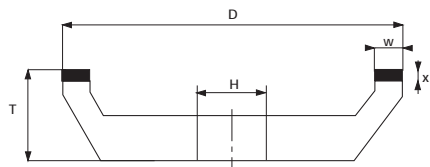

1FF1

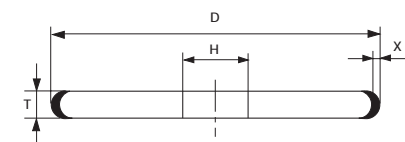

1V1

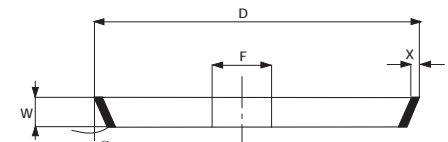

9A3

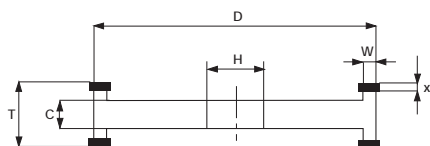

14FF1

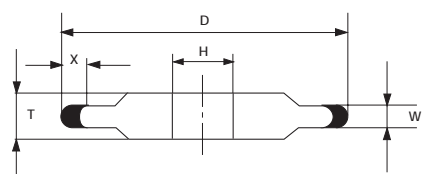

1EE1

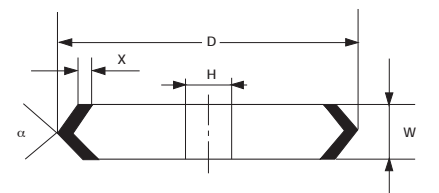

ABRASIVI: DIAMANTE E CBN / ABRASIVES: DIAMOND AND CBN

GRANE: SUPER D213 • GROSSA D151 • MEDIA D107 • FINE D76 / GRAIN SIZE: SUPER D213 • COARSE D151 • MEDIUM D107 • FINE D76



TAZZA CONICA MT / CONICAL CUP MT

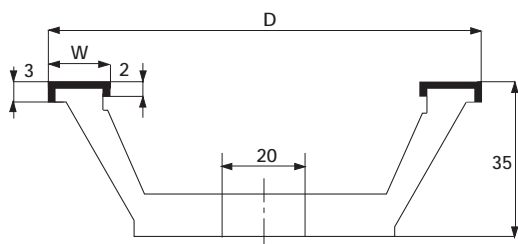

FEPA 11A2

CODICE / CODE	GRANA / GRAIN SIZE	D m/m	W m/m
MT 100 410	D 213	100	10
MT 100 310	D 151	100	10
MT 100 210	D 107	100	10
MT 100 110	D 76	100	10
MT 125 410	D 213	125	10
MT 125 310	D 151	125	10
MT 125 210	D 107	125	10
MT 125 110	D 76	125	10
MT 150 410	D 213	150	10
MT 150 310	D 151	150	10
MT 150 210	D 107	150	10
MT 150 110	D 76	150	10



TAZZA CILINDRICA MTC / CYLINDRICAL CUP MTC

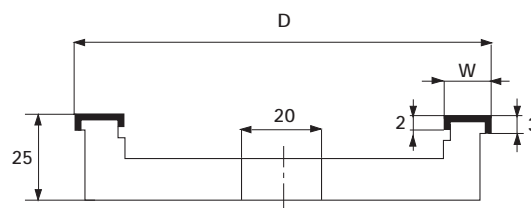

FEPA 6A2

CODICE / CODE	GRANA / GRAIN SIZE	D m/m	W m/m
MTC 100 410	D 213	100	10
MTC 100 310	D 151	100	10
MTC 100 210	D 107	100	10
MTC 100 110	D 76	100	10
MTC 125 410	D 213	125	10
MTC 125 310	D 151	125	10
MTC 125 210	D 107	125	10
MTC 125 110	D 76	125	10
MTC 150 410	D 213	150	10
MTC 150 310	D 151	150	10
MTC 150 210	D 107	150	10
MTC 150 110	D 76	150	10

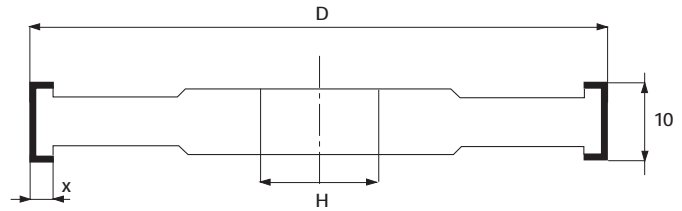

A RICHIESTA / Upon request

GRANULOMETRIE: GROSSA D151 • MEDIA D 107 / GRAIN SIZE: COARSE D 151 • MEDIUM D 107

CODICE CODE	GRANA GRAIN SIZE	D m/m	X m/m	CODICE CODE	GRANA GRAIN SIZE	D m/m	X m/m	CODICE CODE	GRANA GRAIN SIZE	D m/m	X m/m
MP 3100/01	D 151	100	1,5	MP 3175/01	D 151	175	1,5	MP 3300/01	D 151	300	1,5
2100/01	D 107	100	1,5	2175/01	D 107	175	1,5	2300/01	D 107	300	1,5
MP 3100/05	D 151	100	5	MP 3175/05	D 151	175	5	MP 3300/05	D 151	300	5
2100/05	D 107	100	5	2175/05	D 107	175	5	2300/05	D 107	300	5
MP 3100/10	D 151	100	10	MP 3175/10	D 151	175	10				
2100/10	D 107	100	10	2175/10	D 107	175	10				
MP 3125/01	D 151	125	1,5	MP 3200/01	D 151	200	1,5				
2125/01	D 107	125	1,5	2200/01	D 107	200	1,5				
MP 3125/05	D 151	125	5	MP 3200/05	D 151	200	5				
2125/05	D 107	125	5	2200/05	D 107	200	5				
MP 3125/10	D 151	125	10	MP 3200/10	D 151	200	10				
2125/10	D 107	125	10	2200/10	D 107	200	10				
MP 3150/01	D 151	150	1,5	MP 3250/01	D 151	250	1,5				
2150/01	D 107	150	1,5	2250/01	D 107	250	1,5				
MP 3150/05	D 151	150	5	MP 3250/05	D 151	250	5				
2150/05	D 107	150	5	2250/05	D 107	250	5				
MP 3150/10	D 151	150	10	MP 3250/10	D 151	250	10				
2150/10	D 107	150	10	2250/10	D 107	250	10				

ALTRE MISURE A RICHIESTA / OTHER SIZE UPON REQUESTS

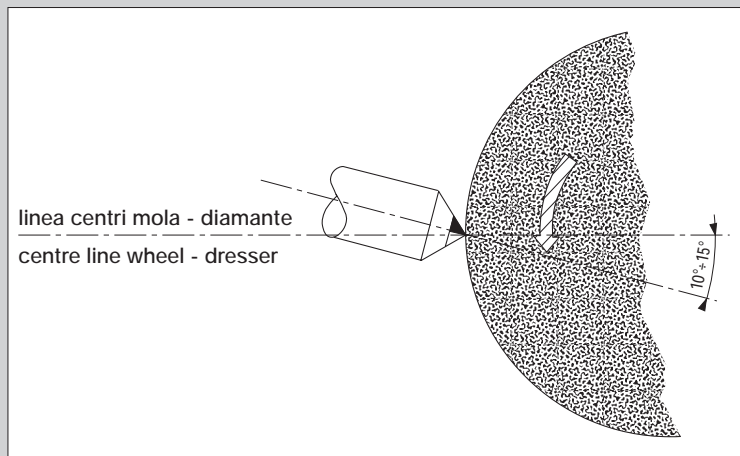

A PUNTA SINGOLA / SINGLE POINT

QUALITÀ DISPONIBILI

QA 1+2 PUNTE DI LAVORO / Colore Giallo Grigio

QN 2+3 PUNTE DI LAVORO / Colore Marrone Chiaro con qualche inclusione ed incrinatura non pericolose per le punte

QS 3+4 PUNTE DI LAVORO / Colore Marrone scuro; possibili leggere inclusioni

AVAILABLE DRESSER TYPES

QA 1+2 WORKING POINTS / Color Yellow Grey

QN 2+3 WORKING POINTS / Color light brown with some inclusion and crack (not dangerous for points)

QS 3+4 WORKING POINTS / Color dark brown with possible weak inclusions

CARATURE DISPONIBILI

QA = 0,30 - 0,50 - 0,75 - 1 - 1,5 - 2 - 3

QN = 0,30 - 0,50 - 0,75 - 1 - 1,5 - 2 - 3

QS = 0,30 - 0,50 - 0,75 - 1 - 1,5

AVAILABLE WEIGHT (CARATS)

QA = 0,30 - 0,50 - 0,75 - 1 - 1,5 - 2 - 3

QN = 0,30 - 0,50 - 0,75 - 1 - 1,5 - 2 - 3

QS = 0,30 - 0,50 - 0,75 - 1 - 1,5

TIPI DI MONTAGGIO - ASSEMBLY TYPES

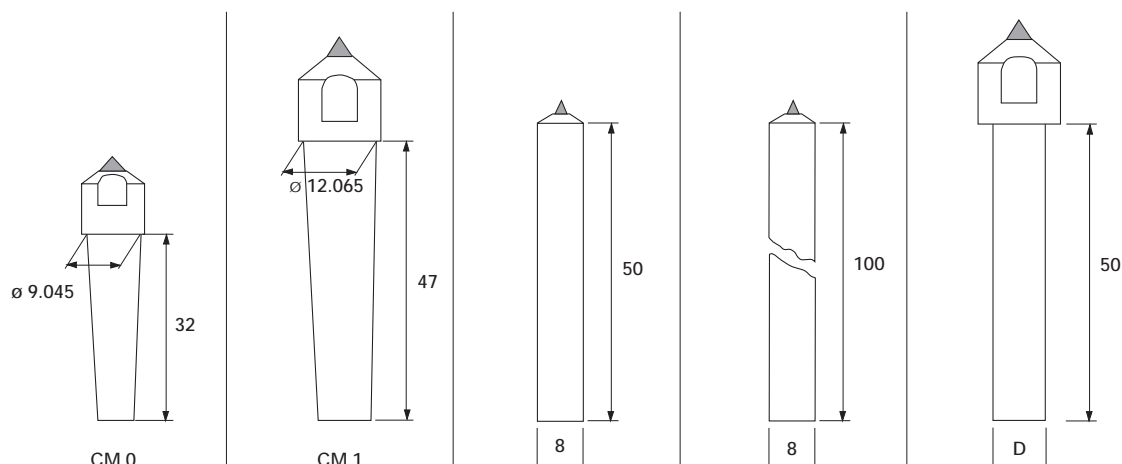

A SINGOLO STRATO TIPO QN / SINGLE LAYER TYPE QN

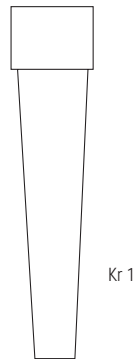
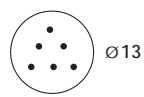

RM 1 QN

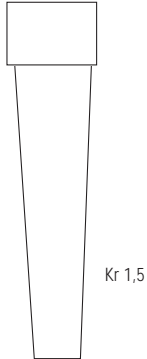

RM 1,5 QN

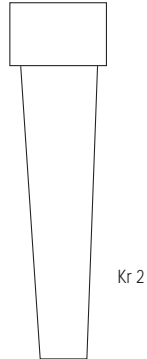

RM 2 QN

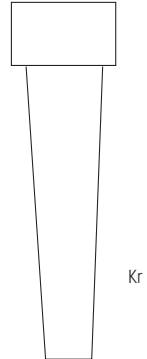
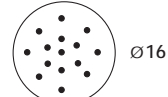

RM 3 QN

A CINQUE STRATI TIPO QS / FIVE LAYER TYPE QS



RM 1 QS

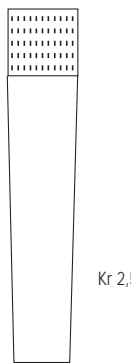

RM 2,5 QS

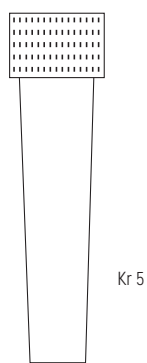
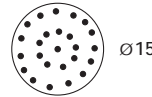

RM 5 QS

A CONCREZIONE (SINTERIZZATI) / DIAMOND IMPREGNATED DRESSERS

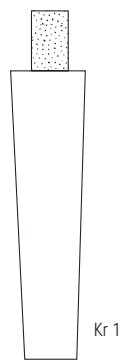

S1

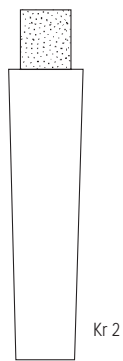

S2

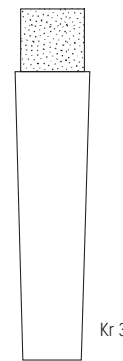

S3

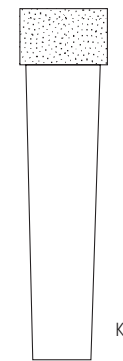

S5

DISPONIBILI	GRANA 25 (D 711)	x MOLA FINO A GRANA	60
	GRANA 30 (D 602)	"	80
	GRANA 40 (D 427)	"	100
	GRANA 50 (D 301)	"	120
	GRANA 70 (D 213)	"	220

AVAILABILITY	GRAIN SIZE 25 (D 711)	x GRINDING WHEEL GRAIN SIZE	60
	GRAIN SIZE 30 (D 602)	"	80
	GRAIN SIZE 40 (D 427)	"	100
	GRAIN SIZE 50 (D 301)	"	120
	GRAIN SIZE 70 (D 213)	"	220

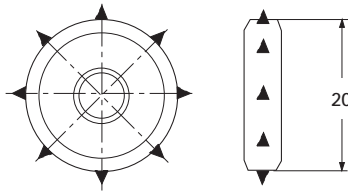

RR 2 N 8 pietre/stones Kr. 2

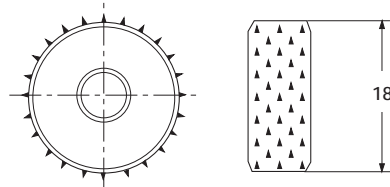

RR 280 80 pietre/stones Kr. 2

RR 380 80 pietre/stones Kr. 3

## DIAMANTI A SCALPELLO / DIAMOND BLADE DRESSING TOOLS

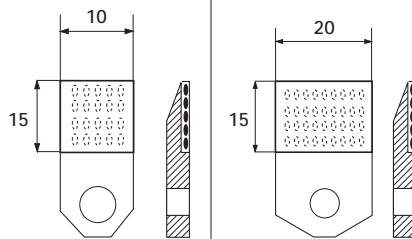

RK 1

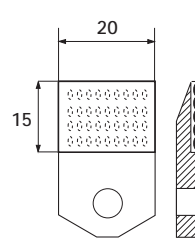

RK 2

## DIAFORM / DIAFORM



QUALITÀ : SUPER ED EXTRA / QUALITY : SUPER AND EXTRA  
 ANGOLI : 40° E 60° / ANGLES : 40° - 60°  
 RAGGI : 0,125 - 0,250 - 0,500 / RADIUS : 0,125 - 0,250 - 0,500



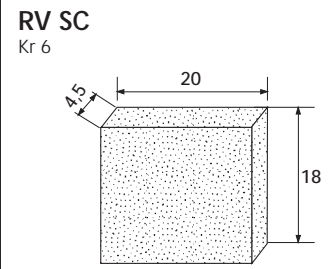
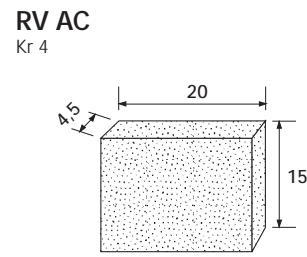
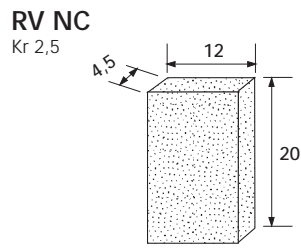
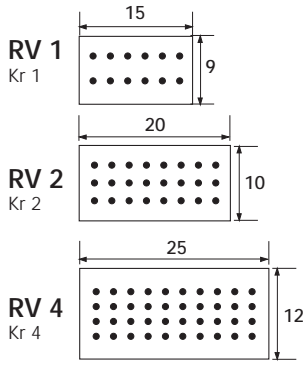

Il programma, **mole diamantate**, è uno dei punti di forza della **TRE D**. La possibilità di produrre in brevissimo tempo sia mole normalizzate FEPA che mole ed utensili su disegno, il tutto completato da un ottimo livello di qualità, ha portato la ns. azienda ai vertici in questo settore.

La diversificazione del legante (galvanico o resinoide) inoltre è in grado di offrire varie soluzioni allo stesso problema.

**Consigli tecnici**

Scelta del legante: **Galvanico** Forte asportazione con ridotto sviluppo di calore e soprattutto quando è indispensabile il rispetto ed il mantenimento della sagoma.

**Resinoide** In tutti quei casi in cui è richiesta una buona finitura (affilatura). Diverse capacità di asportazione si possono ottenere attraverso una scelta appropriata della concentrazione e della grandezza dell'abrasivo. Scelta dell'abrasivo: **Diamante** Lavorazione dei materiali a truciolo corto o polverulento come: metallo duro, ceramiche, vetro e fibre di vetro, grafite, plastiche termoidurenti, ferriti, pietre dure ecc.

**CBN** Lavorazione di materiali duri (oltre 62 HRC) in particolare acciai temperati o cementati, acciai inossidabili, ghisa e leghe di nichel.

**Velocità e modalità d'uso.** Premesso che non ci sono delle rilevanti differenze per le velocità ottimali tra il legante galvanico e quello resinoide, è importante invece tenere presente se l'abrasivo che costituisce l'utensile è **Diamante** o **CBN** e se la lavorazione si effettua a secco o ad umido.

**Diamante:** taglio a secco 14 - 16 mt./sec.  
 taglio a umido 20 - 25 mt./sec.

Come refrigerante utilizzare emulsioni al 2%.

**CBN:** taglio a secco 18 - 20 mt./sec.  
 taglio a umido 30 - 35 mt./sec.

Sono consigliate emulsioni al 3% con oli appositi per **CBN** e dove è possibile i migliori risultati si ottengono utilizzando oli interi.

La tabella delle velocità in ultima pagina, facilita la ricerca del numero dei giri in rapporto al diametro dell'utensile.

Le programme des meules diamantées est un points forts de la **TRE D**. La possibilité de produire en très peu de temps soit meules normalisées FEPA soit meules et outils sur dessin, avec un excellent niveau de qualité, a permis à notre atelier de parvenir au sommet dans ce secteur. La diversification des liants (galvaniques et résineux) en outre est capable d'offrir les solutions les plus variées au meme problème.

**Conseils techniques:**

- Choix du liant: **Galvaniqu** forte extirpation avec un dégagement réduit de chaleur, quand le respect et la conservation de la forme sont indispensables.

**Résineux:** dans tous les cas où une bonne finition (affilage) est demandée. On peut obtenir différentes capacités d'extirpation grâce a' un choix approprié de la concentration et de la grandeur de l'abrasif.

- Choix de l'abrasif: **Diamant** travail des matériaux au copeau court ou possérieux comme: métal dur, céramiques, verre et fibres de verre, grafite, matériaux plastiques thermodurcissables, ferrites, pierres dures etc.

**CBN** travail de matériaux durs (plus de 62 HRC) en particulier les aciers tempérés ou cimentés, aciers inoxydables, la fonte et les alliages de nikel.

**Vitesse et modalités d'emploi:** Si l'on admet qu'il n'ya pas de différences considérables pour les vitesses optimales entre le liant galvanique et celui résineux, il est par contre important de savoir si l'abrasif qui constitue l'outil est un **Diamant** ou **CBN** et si le travail se fait quand les matériaux sont secs ou humides.

**Diamant:** coupe du material sec 14 - 16 mt./sec.  
 coupe du material humide 20 -25 mt./sec.

Comme réfrigérant utilisez des émulsions à 2%.

**CBN:** coupe du material sec 18 - 20 mt./sec.  
 coupe du material humide 30 -35 mt./sec.

On conseille des émulsions à 3% avec des huiles appropriées pour le **CBN** et on obtient des résultats meilleurs en utilisant des huiles entières quand c'est possible.

Le tableau des vitesses en dernière page facilite la recherche de la quantité de tours par rapport au diamètre de l'outil.

The diamond grinding wheel program is one of **TRE D's** strong points. The capability to manufacture and swiftly deliver both wheels according to FEPA Standards and special grinding wheels to customer drawings, tied to excellent quality, has led **TRE D** to the top in this field.

Furthermore, the availability of either electroplated or resin bonded tools, offers various solutions to customer problems.

**Technical advice**

Bond systems: **Galvanic** (Electroplated) Used for high material removal with reduced heat generation and, above all, when having to maintain strict profile tolerances.

Resin Bond Used when high finishing operations are required (i.e. tool sharpening). Different material removal rates can be obtained through an appropriate choice of tools with the correct abrasive size/concentration.

Choice of abrasive: **Diamond** Processing materials with short/dust shaped chips such as tungsten carbide, ceramics, glass and fibre-glass, graphite, thermosetting-plastics, ferrite, jewel stones, etc..

**CBN** Processing of hard material (over 62 Rockwell C) specially hardened or casehardened steels, stainless steels, cast iron and nickel alloys.

**Speed & mode of operation.** There are no substantial differences in setting speeds between electroplated and resin bonded tools however, it is important to consider the type of abrasive (diamond or CBN) and if the tool has to perform in Dry or Wet grinding mode.

Diamond: Dry 14 - 16 m/s.  
 Wet 20 - 25 m/s. Use 2% emulsion cooling agent.

CBN: Dry 18 - 20 m/s.  
 Wet 30 - 35 m/s. Use 3% emulsion with suitable CBN oil

however, if possible, best results can be obtained using straight oil. The speed table, reported on the final page, illustrates the relationship between r.p.m. and the tool diameter.

Die **diamantierte Schleifscheibe**, ist ein sehr wichtiges Programm der **TRE D**.

Die Möglichkeit in sehr kurzer Zeit sowohl normale FEPA-Mol als auch Mol und Werkzeug nach Entwurf herzustellen, dies alles aus sehr guter Qualität, hat unserem Unternehmen an der Spitze dieses Sektors gebracht. Die Verschiedenheit der Binder (galvanisch und harzhaltig) kann sehr viele Lösungen zu einem gleichen Problem geben.

**Technische Ratschläge**

Die Wahl des Binders: **Galvanish** starke Abfuhr mit niedriger Warmentwicklung und vor allem wenn die inhaltung und Bewahrung der Form nötig ist.

**Harzhaltig:** für die Fälle in denen eine sehr gute Bearbeitung gefragt ist. Verschiedene Abfuhren kann man mit eine geeignigte Wahl von der Konzentration und die Größe der Schmirgel erhalten.

Wahl der Schmirgel **Diamant:** Materialbearbeitung mit kurzen oder staubigen Span wie: hartes Metal, Keramik, Glas, und Glasfaser, Graphit, duroplastische Plastik, Ferrit, harte Steine N.S.W.

**CBN:** Bearbeitung von harte Materialien (über 62 HRC) und ganz besonders gehärteter oder zementierter Stahl, rostfreier Stahl, Gußeisen und Nickellegierung.

**Geschwindigkeits- und Gebrauchsanweisungen:** vorausgesetzt daß keine großen Unterschieden bei der optimalen Geschwindigkeit zwischen dem galvanischen und dem harzhaltigen Binder gibt, ist es sehr wichtig zu sehen ob die Schmirgel des Werkzeugs **Diamant** oder **CBN** ist und ob die Bearbeitung bei trockenem oder naßem Zustand ausgeführt wird.

**Diamant:** trockenschnitt 14 - 16 mt./sec.  
 naßschnitt 20 - 25 mt./sec.

für die Kühlung Emulsion zu 2% benutzen.

**CBN:** trockenschnitt 18 - 20 mt./sec.  
 naßschnitt 30 - 35 mt./sec.

Es werden Emulsionen zu 3% empfohlen mit geeignete Öle für **CBN** und dort wo es möglich ist erreicht man mit vollständige Öle die besten Ergebnissen.

Die Geschwindigkeitstabelle auf der letzten Seite, erleichtert die Suche der Drehnummer im Verhältnis zu dem Werkzeugsdurchmesser.

Ø MOLA WHEEL DIAM.	VELOCITÀ PERIFERICA M/SEC. / PERIPHERAL SPEED M/SEC.						
	16	20	24	30	40	50	60
2,5	122.000						
5	61.000	76.400	91.700	114.400			
10	30.500	38.200	45.850	57.300	76.400	95.500	
15	20.400	25.500	30.570	38.200	51.000	63.660	76.400
20	15.280	19.100	22.930	28.660	38.200	47.750	57.300
25	12.230	15.300	18.340	22.930	30.550	38.200	45.840
30	10.190	12.740	15.280	19.100	25.470	31.830	38.200
40	7.640	9.550	11.460	14.330	19.100	23.870	28.650
50	6.110	7.640	9.170	11.460	15.280	19.100	22.920
75	4.070	5.100	6.110	7.640	10.180	12.730	15.280
100	3.050	3.820	4.590	5.730	7.640	9.550	11.460
125	2.440	3.060	3.670	4.590	6.120	7.640	9.170
150	2.040	2.550	3.060	3.820	5.090	6.370	7.640
175	1.750	2.180	2.620	3.270	4.370	5.460	6.550
200	1.530	1.910	2.290	2.860	3.820	4.780	5.730
230	1.330	1.660	1.990	2.490	3.320	4.150	4.980
250	1.220	1.530	1.830	2.290	3.060	3.820	4.580
300	1.010	1.270	1.530	1.910	2.540	3.180	3.820
350	875	955	1.310	1.640	2.180	2.730	3.280
400	765	955	1.145	1.430	1.910	2.390	2.870
450	680	850	1.020	1.275	1.700	2.120	2.550

N. GIRI AL MINUTO R.P.M.

#### CONDIZIONI GENERALI DI VENDITA

- 1 - **OFFERTE** - Le offerte fatte dai ns. agenti sono valide solo se espressivamente approvate dalla casa.
  - 2 - **IMBALLAGGI** - Gli imballaggi sono sempre compresi nei prezzi salvo particolari richieste del cliente.
  - 3 - **TRASPORTI** - Salvo speciali accordi scritti in contratto, le spese di trasporto e qualunque altra spesa o tassa che dovesse gravare sulle merci sono a carico dell'Acquirente.
- In nessun caso la nostra Ditta potrà essere chiamata a rispondere per il fatto di mancate o irregolari consegne da parte delle Ferrovie, Imprese di Navigazione, di Trasporti, Corrieri, ecc., restando assolutamente ed esplicitamente inteso che la merce, anche se per speciali accordi venduta in porto franco, oppure consegnata a domicilio del Cliente, viaggia sempre a totale rischio e pericolo dell'Acquirente.
- 4 - **CONSEGNE** - I termini di consegna indicati ed accettati si intendono valevoli solamente in condizioni normali di lavoro e di approvvigionamento. In nessun caso e per nessun motivo la nostra Ditta è tenuta a corrispondere indennizzi per eventuali danni diretti ed indiretti dovuti a ritardi di consegna e ciò perché i termini indicati ed accettati al momento dell'assunzione dell'ordine non sono impegnativi.
  - 5 - **ORDINAZIONI DI UTENSILI SPECIALI** - La **TRE D** è esonerata da eventuali errori costruttivi di qualsiasi utensile speciale se l'ordine non è effettuato con specifico disegno tecnico e relative istruzioni (vedere ordini telefonici).
  - 6 - **PAGAMENTI** - I pagamenti devono essere effettuati alla nostra sede di Ruvo di Puglia o a ns. personale autorizzato. Il mancato pagamento entro i termini pattuiti, autorizza la **TRE D** all'emissione di tratta a vista gravata degli interessi al tasso bancario vigente.
  - 7 - **RECLAMI E CONTESTAZIONI** - Gli eventuali reclami riguardanti le forniture di merci, dovranno pervenire per iscritto alla nostra Ditta entro otto giorni dal ricevimento delle merci stesse dopodiché essi non saranno più accolti. Ogni reclamo dovrà essere basato su dati di fatto concreti e precisati per poter essere preso in considerazione. Nessun reclamo per vizi, difetti, natura e qualità della merce o ritardi nelle consegne potrà essere fatto valere, neppure in via giudiziaria, se non avrà avuto luogo il regolare pagamento delle partite alle quali il reclamo si riferisce. Nel caso di ritorno autorizzato alla Ditta di merci oggetto di reclamo queste dovranno essere spedite a rischio del mittente in porto franco; in difetto di ciò la nostra Ditta può rifiutarsi al loro ritiro. Per le merci di cui sia stato autorizzato il ritorno ed eventualmente riconosciute difettose la ns. responsabilità si limita alla sostituzione della stessa, nè il Cliente potrà richiere indennizzi od altro, per ritardi o pretesi danni. Resta inteso che per eventuali contestazioni su una singola spedizione di merce non avranno effetto alcuno sul resto dell'ordine. Le ordinazioni vengono date ed accettate alle condizioni tutte sopra esposte che l'Acquirente dichiara di conoscere ed accettare.
  - 8 - La **TRE D** si riserva di modificare il presente catalogo a propria discrezione anche senza preavviso alla spett. Clientela.
  - 9 - **COMPETENZE** - Per tutto quanto si riferisce alle vendite e quindi per ogni azione e contestazione ad esse relative o da esse dipendenti, sono esclusivamente competenti le Autorità Giudiziarie di Ruvo di Puglia, rinunciando le parti ad ogni diritto ed eccezione contraria alla piena osservanza di questa clausola. Quindi le parti eleggono d'accordo il domicilio nella sede della nostra Ditta.
  - 10 - Il conferimento di un'ordine da parte del Cliente fa di sua implicita conoscenza e totale accettazione delle ns. suddette condizioni di vendite, anche in mancanza di ordine e relative conferma scritta.

#### GENERAL CONDITION OF SALE

- 1 - **OFFERS** - Offers from our Agents are only valid if approved by **TRE D**.
- 2 - **PACKING** - Our standard packing is always included in the product price, unless specifically requested of customers.
- 3 - **DELIVERY COSTS** - Unless specifically covered by special written contracts, all transports and/or other product types plus insurance are to be born by the customer.
- 4 - **DELIVERY TIMES** - Agreed to delivery times are valid in case of formal conditions of working and material purchasing. In no case will **TRE D** be held responsible and be obliged to reimbursements for direct or indirect damages to customs caused by eventual delivery delays.
- 5 - **SPECIAL TOOL ORDERS** - **TRE D** will not be responsible for any eventual manufacturing error of special tools unless the customer attaches an appropriate technical drawing with all the related specific (see phone orders).
- 6 - **PAYEMENTS** - All payments must be sent to our Company in Ruvo di Puglia through authorized Bank Transfers to be agreed upon at definition of the single orders.
- 7 - **CLAIMS** - Eventual claims regarding deliveries must be sent to **TRE D** in writing within eight days receipt of the tools, unless based on concrete facts, **TRE D** will not consider the claims.

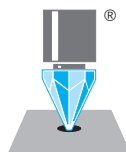

**TRED**

Società a responsabilità limitata

**70037 RUVO DI PUGLIA (Italy)**

Piazza Amenduni, 13/14 (zona ind.) Tel. 0039/080 3601675 pbx Fax 080 3612800 - 080 3602535  
<http://www.tre-d.it> e-mail: [info.tred@tin.it](mailto:info.tred@tin.it)